

Main MSP430F5529 w Power, Clock and USB	
TITLE: MSP-EXP430F5529LP	
Document Number:	REV: 1.6
Date: 7/27/2014 8:09:01 PM	Sheet: 1/4

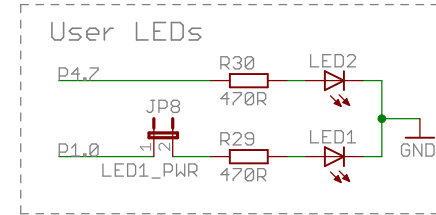

40 pin BoosterPack Headers

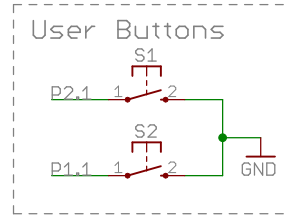
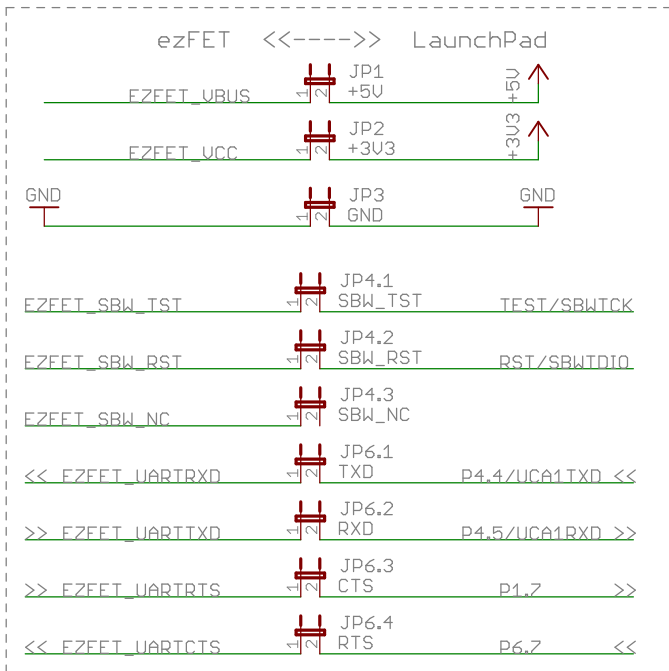
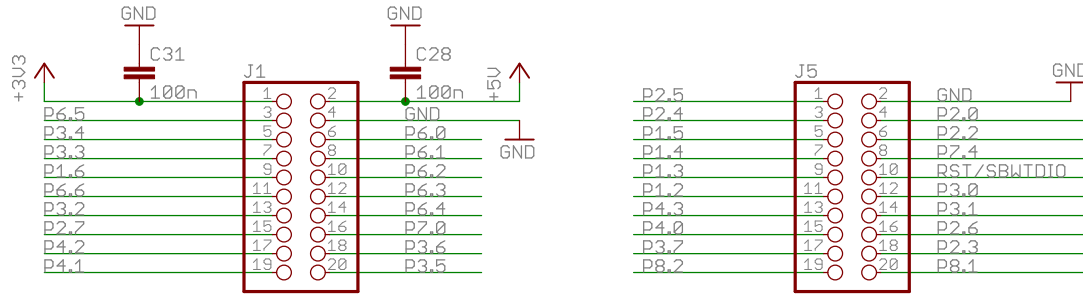

3V3

- U\$7 MOUNTHOLE_125MIL
- U\$9 MOUNTHOLE_125MIL
- U\$8 MOUNTHOLE_125MIL
- U\$10 MOUNTHOLE_125MIL

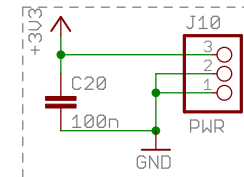
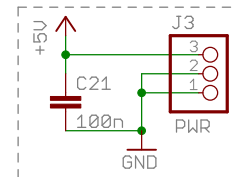

Connections

TITLE: MSP-EXP430F5529LP

Document Number:

REV: 1.6

Date: 7/27/2014 8:09:01 PM

Sheet: 2/4

eZ-FET lite Emulator

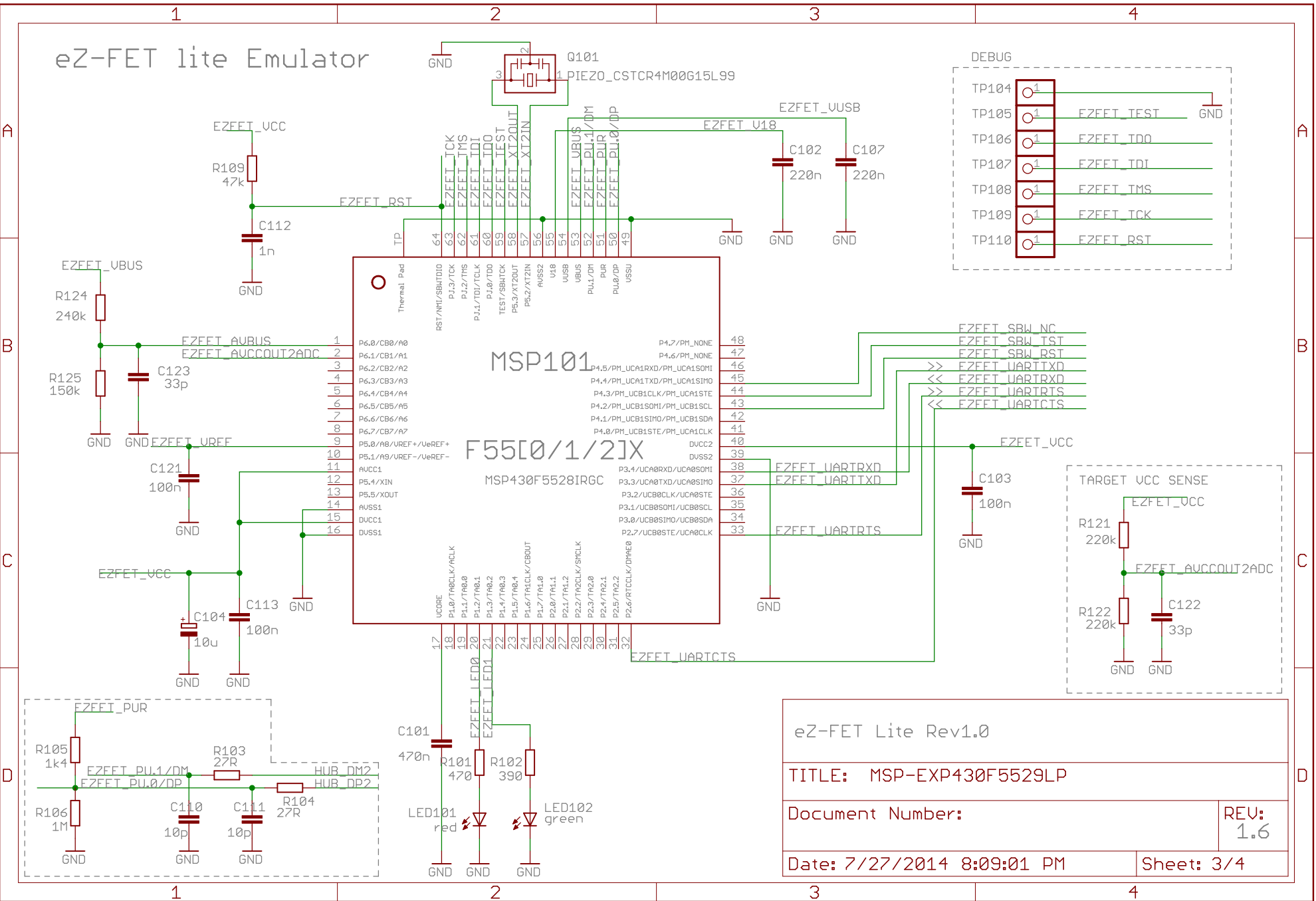

eZ-FET Lite Rev1.0

TITLE: MSP-EXP430F5529LP

Document Number: [blank]

REV: 1.6

Date: 7/27/2014 8:09:01 PM

Sheet: 3/4

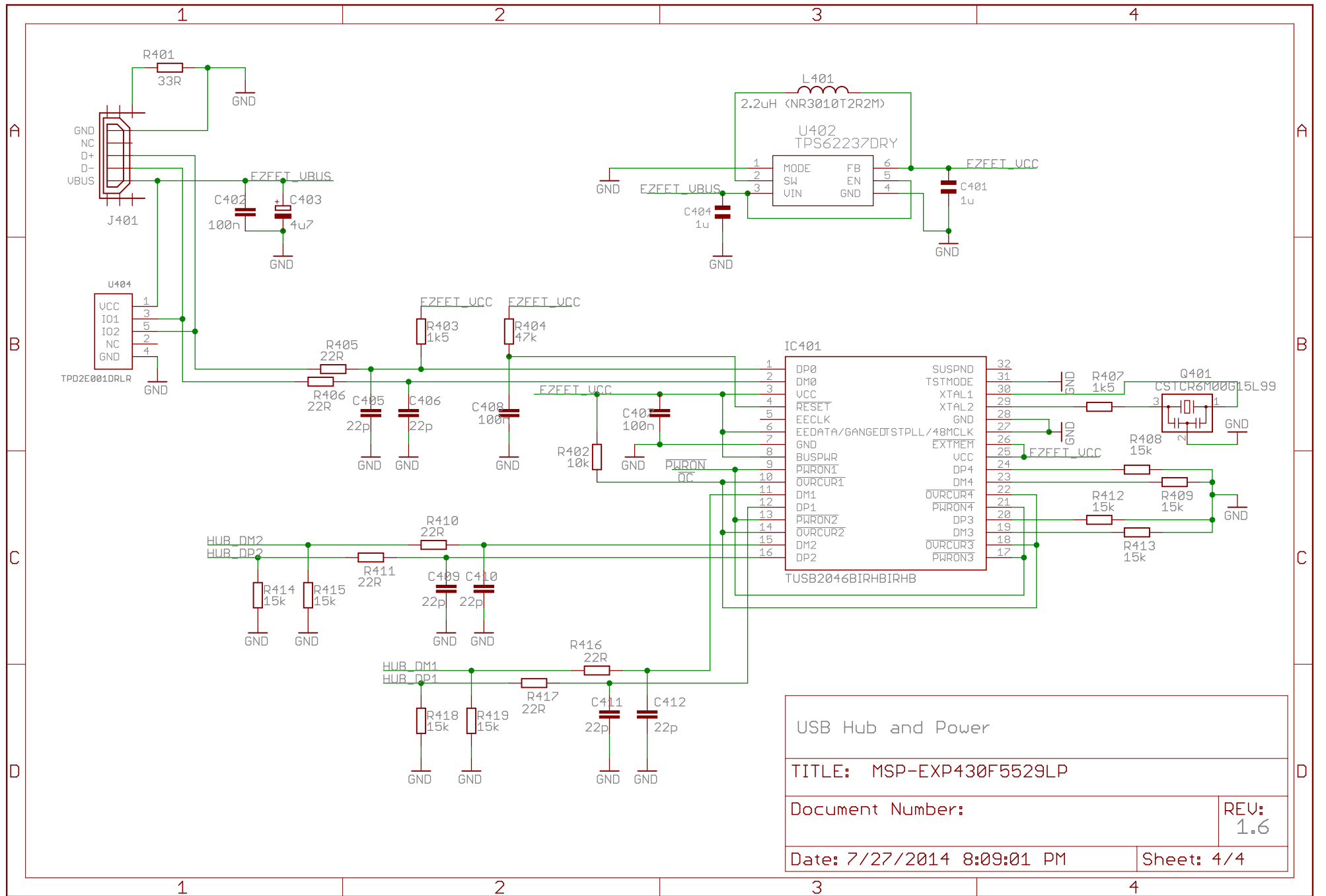

USB Hub and Power	
TITLE: MSP-EXP430F5529LP	
Document Number:	REV: 1.6
Date: 7/27/2014 8:09:01 PM	Sheet: 4/4